

## MODEL LD - LARGE SERIAL SLAVE DISPLAY



- 2.25" or 4" HIGH RED LED DIGITS
- DISPLAYS UP TO 6 DIGITS OF SERIAL ASCII DATA
- DUAL DISPLAY BUFFER ALLOWS ALTERNATING DISPLAYS
- RS232 OR RS485 SERIAL INTERFACE
- CONNECTS DIRECTLY TO RED LION PRODUCTS WITH SERIAL
- PROGRAMMABLE USER INPUT
- UNIVERSALLY POWERED
- ALUMINUM NEMA 4X/IP65 CASE CONSTRUCTION



### GENERAL DESCRIPTION

The Large Serial Slave Display is a versatile display that accepts serial ASCII data from a host device and displays the received characters. The displayable data includes numeric, 7-segment alphabetic and certain punctuation characters.

The 6-digit displays are available in either 2.25" or 4" high red LED digits with adjustable display intensity. The 2.25" high models are readable up to 130 feet. The 4" high models are readable up to 180 feet. Both versions are constructed of a NEMA 4X/IP65 enclosure in light weight aluminum.

The Serial Slave has two internal display buffers, allowing two separate display values or messages to be viewed. The main (primary) display typically shows dynamic data (count, rate, process, etc.), usually received directly from another meter. The secondary display typically shows a fixed message or value, such as a system or machine identifier, or a target production value. The main and secondary displays can be toggled either manually or automatically at a user selected toggle speed. Both displays are retained in memory when power is removed from the unit.

For single meter remote display applications, the Serial Slave can be connected directly to a Red Lion (or compatible) meter with RS232 or RS485 serial communications. The slave can display the meter value on its main display without requiring a PC or other serial interface.

Multiple slaves are connected using an RS485 serial bus. If unique meter addresses are assigned, specific data can be displayed by a single slave on the bus. When multiple slaves are assigned the same address, common data can be displayed by multiple units in different locations.

Serial communications parameters are fully programmable, with baud rates up to 38.4 Kbps. Special command characters allow display selection and display intensity adjustment through the serial input. In addition to the serial input, a programmable User Input is provided to perform a variety of meter functions.

### SAFETY SUMMARY

All safety regulations, local codes and instructions that appear in this and corresponding literature, or on equipment, must be observed to ensure personal safety and to prevent damage to either the instrument or equipment connected to it. If equipment is used in a manner not specified by the manufacturer, the protection provided by the equipment may be impaired.

Do not use this unit to directly command motors, valves, or other actuators not equipped with safeguards. To do so can be potentially harmful to persons or equipment in the event of a fault to the unit.



The protective conductor terminal is bonded to conductive parts of the equipment for safety purposes and must be connected to an external protective earthing system.

### SPECIFICATIONS

1. **DISPLAY:** 6-digit 2.25" (57 mm) or 4" (101 mm) adjustable intensity Red LED
2. **POWER REQUIREMENTS:**  
 AC POWER: 50 to 250 VAC 50/60 Hz, 26 VA  
 DC POWER: 21.6 to 250 VDC, 11 W  
 Isolation: 3000 V<sub>RMS</sub> for 1 min. to all inputs and outputs
3. **SERIAL INPUT:**  
 RS485 SERIAL COMMUNICATIONS  
 Type: Multi-point balanced interface (isolated)  
 Baud Rate: 300 to 38400  
 Data Format: 7/8 bits; odd, even, or no parity  
 Bus Address: 0 to 99; max 32 meters per line  
 RS232 SERIAL COMMUNICATIONS  
 Type: Half duplex (isolated)  
 Baud Rate: 300 to 38400  
 Data Format: 7/8 bits; odd, even, or no parity
4. **USER INPUT** (Programmable Function Input):  
 Active low logic, internal 7.8 K $\Omega$  pull-up resistor to +12V.  
 Trigger levels: V<sub>IL</sub> = 1.0 V max; V<sub>IH</sub> = 2.4 V min; V<sub>MAX</sub> = 28 VDC  
 Response time: 10 msec typ; 50 msec debounce (activation & release)

**CAUTION: Risk of Danger.**  
 Read complete instructions prior to installation and operation of the unit.

**CAUTION: Risk of electric shock.**

### DIMENSIONS In inches (mm)

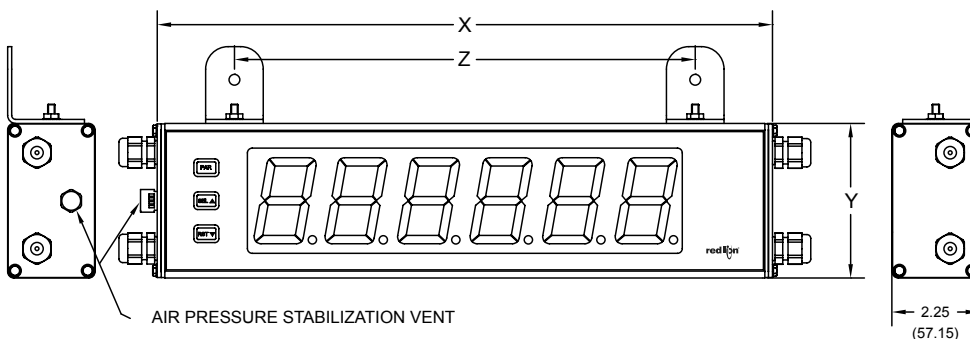

PART NUMBER	X (Length)	Y (Height)	Z (Center)
LD2SS6P0	16 (406.4)	4 (101.6)	12 (304.8)
LD4SS6P0	26 (660.4)	7.875 (200)	22 (558.8)

5. **MEMORY:** Nonvolatile E<sup>2</sup>PROM retains all programming parameters, main and secondary displays when power is removed.
6. **CERTIFICATIONS AND COMPLIANCES:**  
**CE Approved**  
 EN 61326-1 Immunity to Industrial Locations  
 Emission CISPR 11 Class B  
 Safety requirements for electrical equipment for measurement, control, and laboratory use:  
 EN 61010-1: General Requirements  
 EN 61010-2-030: Particular Requirements for Testing and Measuring Circuits  
 RoHS Compliant  
 UL Listed: File #E137808  
 Type 4X Indoor/Outdoor Enclosure rating  
 IP65 Enclosure rating
7. **CONNECTIONS:** Internal removable terminal blocks  
 Wire Strip Length: 0.4" (10 mm)  
 Wire Gauge: 24-12 AWG (0.51-2.05 mm) copper wire, 90°C rated insulation only  
 Torque: 5.3 inch-lbs (0.6 N-m) max  
 Cable Diameter: Outside diameter must be 0.181" (4.6 mm) to 0.312" (7.9 mm) to maintain Type 4X rating of cord grips.

8. **ENVIRONMENTAL CONDITIONS:**  
 Operating temperature: 0 to 65 °C  
 Storage temperature: -40 to 70 °C  
 Operating and storage humidity: 0 to 85% max. RH (non-condensing)  
 Vibration to IEC 68-2-6: Operational 5 to 150 Hz, 2 g (1 g relay).  
 Shock to IEC 68-2-27: Operational 30 g (10 g relay).  
 Altitude: Up to 2,000 meters
9. **CONSTRUCTION:** Aluminum enclosure, and steel side panels with textured black polyurethane paint for scratch and corrosion resistance protection. Sealed front panel meets Type 4X/IP65 specifications. Installation Category II, Pollution Degree 2.
10. **WEIGHT:**  
 LD2SS6P0: 4.5 lbs (2.04 kg)  
 LD4SS6P0: 10.5 lbs (4.76 kg)

## ORDERING INFORMATION

MODEL NO.	DESCRIPTION	PART NUMBER
LD2SS	2.25" High 5 Digit Red LED Serial Slave Display, RS232/RS485 Serial Communications	LD2SS6P0
LD4SS	4" High 6-Digit Red LED Serial Slave Display, RS232/RS485 Serial Communications	LD4SS6P0
LD Plug	Cord Grip Plug for LD models *	LDPLUG00

\* Required to maintain Type 4X/IP65 specification, if end plate cord grip does not have cable installed.

# 1.0 INSTALLING THE METER

## INSTALLATION

The meter meets NEMA 4X/IP65 requirements when properly installed.

## INSTALLATION ENVIRONMENT

The unit should be installed in a location that does not exceed the operating temperature. Placing the unit near devices that generate excessive heat should be avoided. The unit should only be cleaned with a soft cloth and neutral soap product. Do NOT use solvents.

Continuous exposure to direct sunlight may accelerate the aging process of the front overlay. Do not use tools of any kind (screwdrivers, pens, pencils, etc.) to operate the keypad of the unit.

## MOUNTING INSTRUCTIONS

This display is designed to be wall mounted or suspended from a ceiling truss or other suitable structure capable of supporting the LDSS. Caution should be exercised when hanging the display to provide for the safety of personnel. If hanging the LDSS, run the suspension cables (or chains) through the mounting bracket holes. For wall mounting use #10-32 size bolts.

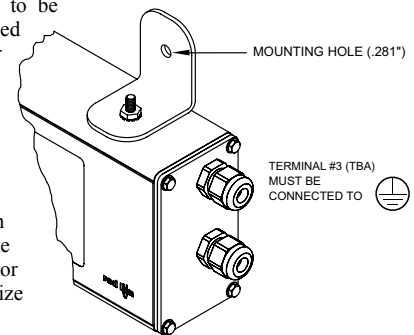

# 2.0 WIRING THE METER

## EMC INSTALLATION GUIDELINES

Although Red Lion Controls Products are designed with a high degree of immunity to Electromagnetic Interference (EMI), proper installation and wiring methods must be followed to ensure compatibility in each application. The type of the electrical noise, source or coupling method into a unit may be different for various installations. Cable length, routing, and shield termination are very important and can mean the difference between a successful or troublesome installation. Listed are some EMI guidelines for a successful installation in an industrial environment.

1. A unit should be mounted in a metal enclosure, which is properly connected to protective earth.
2. Use shielded cables for all Signal and Control inputs. The shield connection should be made as short as possible. The connection point for the shield

depends somewhat upon the application. Listed below are the recommended methods of connecting the shield, in order of their effectiveness.

- a. Connect the shield to earth ground (protective earth) at one end where the unit is mounted.
  - b. Connect the shield to earth ground at both ends of the cable, usually when the noise source frequency is over 1 MHz.
3. Never run Signal or Control cables in the same conduit or raceway with AC power lines, conductors, feeding motors, solenoids, SCR controls, and heaters, etc. The cables should be run through metal conduit that is properly grounded. This is especially useful in applications where cable runs are long and portable two-way radios are used in close proximity or if the installation is near a commercial radio transmitter. Also, Signal or Control cables within

an enclosure should be routed as far away as possible from contactors, control relays, transformers, and other noisy components.

4. Long cable runs are more susceptible to EMI pickup than short cable runs.
5. In extremely high EMI environments, the use of external EMI suppression devices such as Ferrite Suppression Cores for signal and control cables is effective. The following EMI suppression devices (or equivalent) are recommended:

Fair-Rite part number 0443167251 (RLC part number FCOR0000)

Line Filters for input power cables:

Schaffner # FN2010-1/07 (Red Lion Controls # LFIL0000)

6. To protect relay contacts that control inductive loads and to minimize radiated and conducted noise (EMI), some type of contact protection network is normally installed across the load, the contacts or both. The most effective location is across the load.
  - a. Using a snubber, which is a resistor-capacitor (RC) network or metal oxide varistor (MOV) across an AC inductive load is very effective at reducing EMI and increasing relay contact life.

- b. If a DC inductive load (such as a DC relay coil) is controlled by a transistor switch, care must be taken not to exceed the breakdown voltage of the transistor when the load is switched. One of the most effective ways is to place a diode across the inductive load. Most RLC products with solid state outputs have internal zener diode protection. However external diode protection at the load is always a good design practice to limit EMI. Although the use of a snubber or varistor could be used.

RLC part numbers: Snubber: SNUB0000

Varistor: ILS11500 or ILS23000

7. Care should be taken when connecting input and output devices to the instrument. When a separate input and output common is provided, they should not be mixed. Therefore a sensor common should NOT be connected to an output common. This would cause EMI on the sensitive input common, which could affect the instrument's operation.

Visit RLC's web site at <http://www.redlion.net/emi> for more information on EMI guidelines, Safety and CE issues as they relate to Red Lion Controls products.

## WIRING OVERVIEW

Electrical connections are made via pluggable terminal blocks located inside the meter. All conductors should conform to the meter's voltage and current ratings. All cabling should conform to appropriate standards of good installation, local codes and regulations. It is recommended that the power supplied to the meter (DC or AC) be protected by a fuse or circuit breaker. When wiring the meter, compare the numbers on the label on the back of the meter case against those shown in wiring drawings for proper wire position. Strip the wire, leaving approximately 0.4" (10 mm) bare lead exposed (stranded wires should be tinned with solder.) Insert the lead under the correct screw clamp terminal and tighten until the wire is secure. (Pull wire to verify tightness.) Each terminal can accept up to one #14 AWG (2.55 mm) wire, two #18 AWG (1.02 mm), or four #20 AWG (0.61 mm). Use copper conductors only, with insulation rated at 90°C.

## WIRING CONNECTIONS

Internal removable terminal blocks are used for power and signal wiring. Access to terminal blocks is through conduit fittings. Remove end plates with 1/4" nut driver. For LD4 versions, all wiring is on right side of unit. For LD2 versions, power and relay wiring is on the right side and the input, serial, DC out and user input is on the left side.

Feed the wire stripped end of cable(s) through the cord grip(s). Un-plug the internal removable terminal blocks and wire appropriately.

Plug in the terminal blocks, connect the drain wire from shielded cable(s) to the screw on the side plate for proper grounding, and slide the end plate(s) into place and tighten to case. Hand tighten all cap screws and then tighten the cap screws at the opposite corner diagonally.

**Important:** To maintain the Type 4X/IP65 specification, the cord grip must be tightened around a cable with an outside diameter of 0.181" (4.6 mm) to 0.312" (7.9 mm). If the cord grip is unused, remove it and replace with the LD cord grip plug (part # LDPLUG00). The LDPLUG00 must be ordered separately.

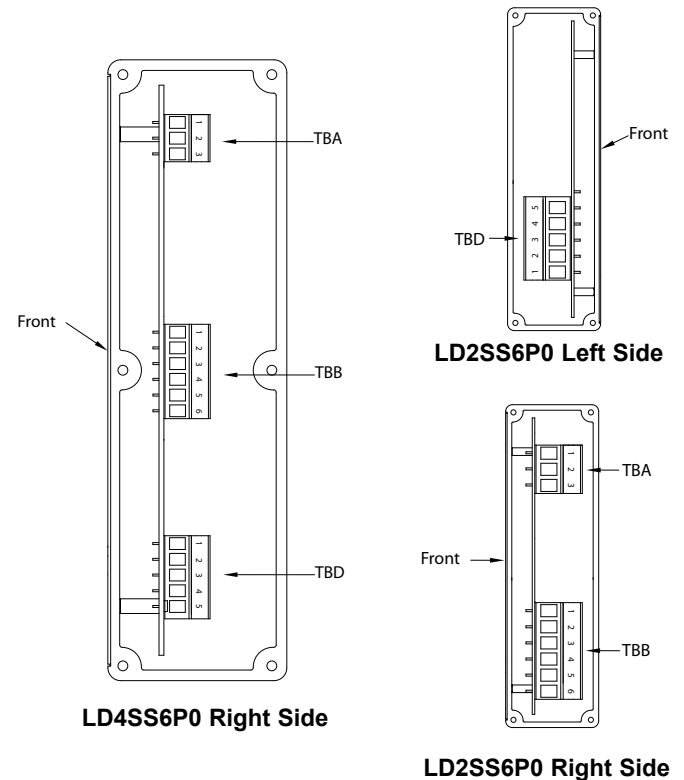

## 2.1 POWER WIRING

The power wiring is made via the 3 position terminal block (TBA) located inside unit (right side).

### AC Power

- Terminal 1: VAC/DC +
- Terminal 2: VAC/DC -
- Terminal 3: Earth Ground

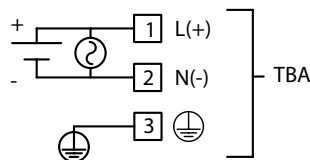

## 2.2 USER INPUT WIRING

The User Input is wired to Terminals 5 and 6 of TBB as shown.

- Terminal 5: User Input
- Terminal 6: User Common

### Sinking Logic

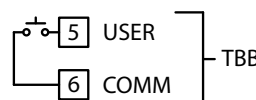

## 2.3 SERIAL WIRING

The serial connections are made via terminal block TBD located inside the unit on the left side for the LD2 and on the right side for the LD4.

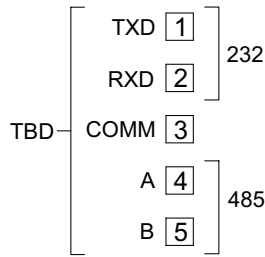

### RS232 Communications

RS232 is intended to allow two devices to communicate over distances up to 50 feet. Data Terminal Equipment (DTE) transmits data on the Transmitted Data (TXD) line and receives data on the Received Data (RXD) line. Data Computer Equipment (DCE) receives data on the TXD line and transmits data on the RXD line. The LD emulates a DTE, the TXD and RXD lines must be interchanged for communications to take place. This is known as a null modem connection.

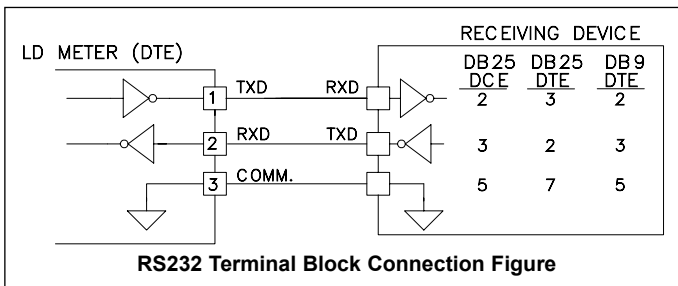

### RS485 Communications

The RS485 communication standard allows the connection of up to 32 devices on a single pair of wires, distances up to 4,000 ft. and data rates as high as 10M baud (the LDSS is limited to 38.4k baud). The same pair of wires is used to both transmit and receive data. RS485 is therefore always half-duplex, that is, data cannot be received and transmitted simultaneously.

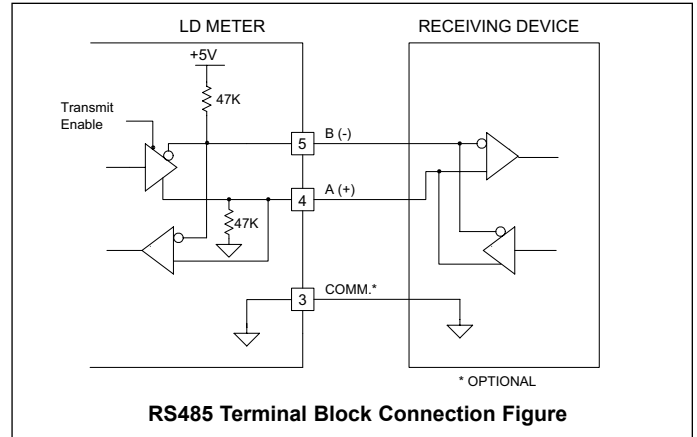

## 3.0 REVIEWING THE FRONT PANEL KEYS AND DISPLAY



#### KEY DISPLAY MODE OPERATION

- PAR** Access Programming Mode
- SEL ▲** Select display (main or secondary)
- RST ▼** Reset display(s) per front panel reset setting

#### PROGRAMMING MODE OPERATION

- Store selected parameter and index to next parameter
- Advance through selection list/select digit position in parameter value
- Increment selected digit of parameter value

#### DISPLAY DESIGNATOR

“ 2 ” - To the far right of the display indicates the secondary display is shown.

If display scroll is enabled, the display will toggle automatically between the main and secondary display at the selected scroll interval.

# 4.0 PROGRAMMING THE METER

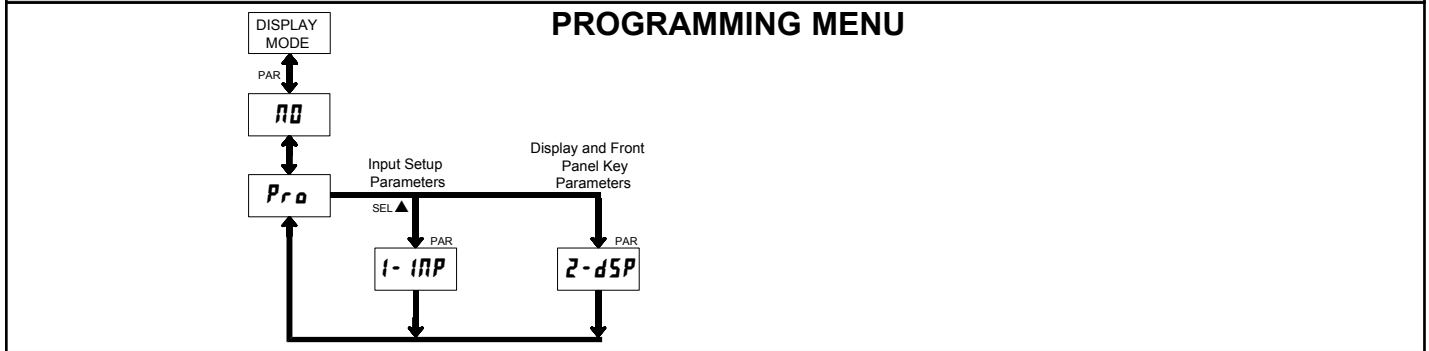

## PROGRAMMING MODE ENTRY (PAR KEY)

It is recommended all programming changes be made off line, or before installation. The meter normally operates in the Display Mode. No parameters can be programmed in this mode. The Programming Mode is entered by pressing the **PAR** key. If it is not accessible, then it is locked by either a security code or a hardware lock (See Module 2).

## MODULE ENTRY (SEL▲ & PAR KEYS)

The Programming Menu is organized into two modules. These modules group together parameters that are related in function. The display will alternate between **PrO** and the present module. The **SEL▲** key is used to select the desired module. The displayed module is entered by pressing the **PAR** key.

## MODULE MENU (PAR KEY)

Each module has a separate module menu (which is shown at the start of each module discussion). The **PAR** key is pressed to advance to a particular parameter to be changed, without changing the programming of preceding parameters. After completing a module, the display will return to **PrO**. Programming may continue by accessing additional modules.

## SELECTION / VALUE ENTRY

For each parameter, the display alternates between the present parameter and the selections/value for that parameter. The **SEL▲** and **RST▼** keys are used to move through the selections/values for that parameter. Pressing the **PAR** key, stores and activates the displayed selection/value. This also advances the meter to the next parameter.

For numeric values, the value is displayed with one digit flashing (initially the right most digit). Pressing the **RST▼** key increments the digit by one or the user can hold the **RST▼** key and the digit will automatically scroll. The **SEL▲** key will select the next digit to the left. Pressing the **PAR** key will enter the value and move to the next parameter.

## PROGRAMMING MODE EXIT (PAR KEY)

The Programming Mode is exited by pressing the **PAR** key with **PrO** displayed. This will commit any stored parameter changes to memory and return the meter to the Display Mode. (If power loss occurs before returning to the Display Mode, verify recent parameter changes.)

## PROGRAMMING TIPS

It is recommended to start with Module 1 and proceed through each module in sequence. When programming is complete, it is recommended to record the parameter programming and lock out parameter programming with the user input or programming security code.

## FACTORY SETTINGS

Factory Settings may be completely restored in Module 2. This is useful when encountering programming problems or in the event of corrupted program data.

## ALTERNATING SELECTION DISPLAY

In the explanation of the modules, the following dual display with arrows will appear. This is used to illustrate the display alternating between the parameter on top and the parameter's Factory Setting on the bottom. In most cases, selections and values for the parameter will be listed on the right.

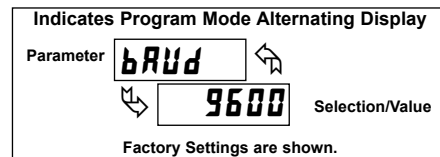

# 4.1 MODULE 1 - INPUT SETUP PARAMETERS (1-INP)

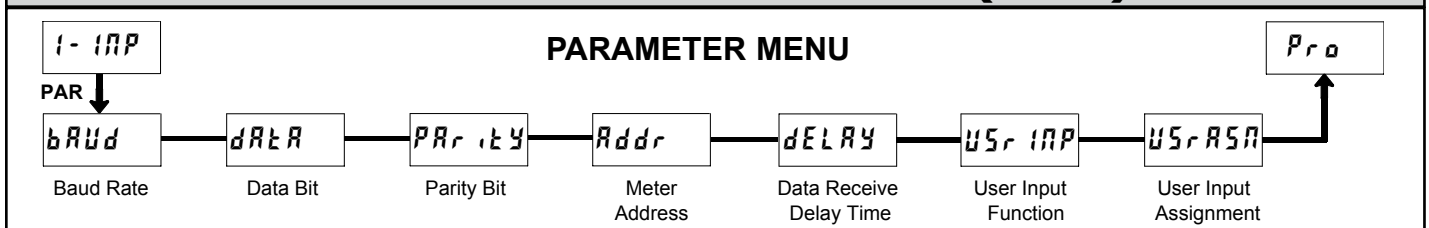

Module 1 is the programming module for the Input Setup Parameters. This includes the Serial Input setup parameters and the User Input function. Set the Serial Input parameters to match the settings of the host device.

## BAUD RATE



Set the baud rate to match that of the host device. Normally, the baud rate is set to the highest value that all the serial communications equipment is capable of transmitting and receiving.

## DATA BIT



Select either 7- or 8-bit data word length to match that of the host device.

### PARITY BIT

**PARITY**

Odd Even No

Odd

This parameter only appears when the Data Bit parameter is set to 7-bit. Set the parity bit to match that of the host device. If parity is set to **No**, an additional stop bit is used to force the frame size to 10 bits.

### METER ADDRESS

**Addr**

0 to 99

00

Enter the meter (node) address. With a single slave unit, an address is not required and a value of zero should be used. This is the case with an RS232 connection, where only one Serial Slave is connected to the host.

With multiple Serial Slaves connected on an RS485 bus, a unique address number must be assigned to each unit in order to send data to a specific slave on the bus. If multiple slaves are assigned the same address (including zero), common data can be sent to, and displayed by multiple slave units on the bus.

### DATA RECEIVE DELAY TIME

**DELAY**

00.01 to 99.99

00.05

Upon receiving a terminator character <CR>, the Serial Slave disables serial data reception for the time duration entered in this parameter. Using a delay allows the Serial Slave to ignore additional characters such as a <LF> or second <CR>, which often follow a serial data string. This value is entered in seconds and hundredths of seconds format, with a 10 msec minimum delay time.

(See "Data Receive Delay Timing" in the Communications section for additional timing details.)

### USER INPUT FUNCTION

**USR INP**

No

No

DISPLAY	MODE	DESCRIPTION
	No	No Function
	No Function	User Input disabled.
<b>Pr oLo c</b>	Program Mode Lock-out	See Programming Mode Access chart (Module 2).
<b>r 5t -E</b>	Momentary Reset (Edge triggered)	Momentary reset of the assigned display(s).
<b>r 5t -L</b>	Maintained Reset	Level active reset of the assigned display(s).
<b>d -HOL d</b>	Display Hold	Freeze the assigned display(s) as long as the input is active.
<b>d -SEL</b>	Display Select (Edge triggered)	Toggle between main and secondary display (if enabled).
<b>d -LEU</b>	Display Intensity Level (Edge triggered)	Increase intensity one level for each activation.

### USER INPUT ASSIGNMENT

**USR ASN**

Pr i both

SEC dSP

dSP

Select the display to which the User Input Function applies. The User Input Assignment only appears if the secondary display is enabled and a selection of reset or display hold is chosen for the User Input Function.

Assignment choices include the main (primary) and/or secondary display, or the display which is shown at the moment the User Input is activated (**dSP**).

*Note: For reset selection, main display resets to zero. Secondary display resets to all blanks.*

## 4.2 MODULE 2 - DISPLAY AND FRONT PANEL KEY PARAMETERS (2-dSP)

### PARAMETER MENU

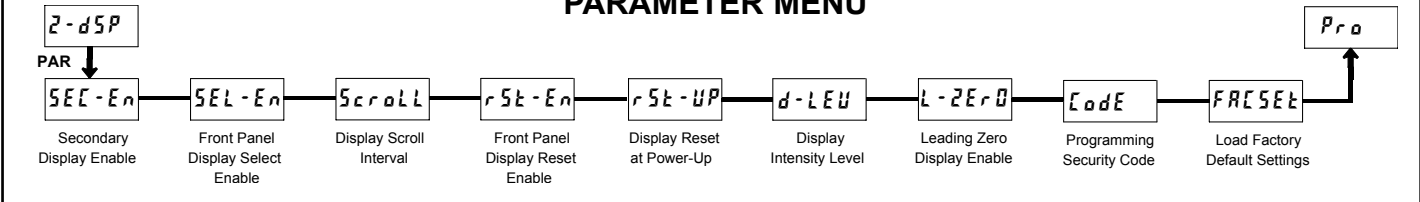

### SECONDARY DISPLAY ENABLE

**SEC-En**

No YES

YES

Select **YES** to enable the secondary display. A "2" on the far right of the display always appears when the secondary display is shown.

### DISPLAY SCROLL INTERVAL

**Scroll**

No 4-SEC 8-SEC

2-SEC 6-SEC 10-SEC

No

Select the time interval at which the display automatically toggles between the main and secondary displays. Select **No** to disable automatic scrolling. This parameter only appears if the secondary display is enabled.

### FRONT PANEL DISPLAY SELECT ENABLE (SEL▲)

**SEL-En**

No YES

YES

Select **YES** to allow the **SEL▲** key to toggle between the main and secondary displays. This parameter only appears if the secondary display is enabled.

### FRONT PANEL DISPLAY RESET ENABLE (RST▼)

**RST-En**

No SEC dSP

Pr i both

dSP

This parameter allows the **RST▼** key to reset the main (primary) and/or secondary display (if enabled), or the display which is currently shown (**dSP**). Select **No** to disable the **RST▼** key.

*Note: Main display resets to zero. Secondary display resets to all blanks.*

### DISPLAY RESET AT POWER-UP



This parameter allows the Main and/or Secondary display (if enabled) to automatically reset when power is applied to the unit.

### DISPLAY INTENSITY LEVEL



Enter the desired display intensity level. The display will actively brighten or dim as the level is changed.

### LEADING ZERO DISPLAY ENABLE



Select **no** to insert blanks in place of any leading zeros received in a serial data string. This is typical when sending numeric values to the slave. Select **YES** to enable display of any leading zeros in the string. This parameter setting only applies to the Main display.

### PROGRAMMING SECURITY CODE

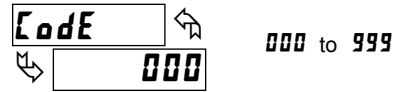

The Security Code determines the user access to Programming mode. This code can be used independently or along with the Program Mode Lock-out (**PrLoac**) selection in the User Input Function parameter (Module 1).

Programming a Security Code other than 0, requires this code to be entered at the **Code** prompt in order to access Programming mode.

USER INPUT FUNCTION	USER INPUT STATE	SECURITY CODE	PROGRAMMING ACCESS WHEN "PAR" PRESSED
not <b>PrLoac</b>	---	0	Immediate Access
		1-999	With correct code entry at <b>Code</b> prompt *
<b>PrLoac</b>	Active	0	Programming Locked No Access
		1-999	With correct code entry at <b>Code</b> prompt *
	Not Active	0-999	Immediate Access

\* Entering Code 222 allows access regardless of security code.

### LOAD FACTORY DEFAULT SETTINGS



The **YES** selection returns the slave to the factory default settings. The unit will display **rESEt** and returns to **Pr**, with the factory settings loaded.

## Serial Slave Communications

### Displayable Characters

The ASCII characters that the Serial Slave can display are as follows:

**Numeric:** 0 to 9

**Alphabetic (7-segment):** A, b, C, c, d, E, e, F, G, g, H, h, I, i, J, K, L, l, N, n, O, o, P, q, r, S, t, U, u, V, v, Y, Z

Non-displayable alphabetic characters will be replaced with a blank if received. These include M, W and X.

*Note: Both uppercase and lowercase ASCII characters are accepted. If a displayable difference exists, characters will be shown in the case received.*

**Punctuation:** period, comma, and colon (all displayed as decimal point); minus (dash), blank

### Display and Serial Buffer Capacity

The Serial Slave display is right aligned and has the capacity of displaying six characters. When less than six characters are received, blank spaces are placed in front of the characters. If more than six characters are received, only the last six are displayed.

The unit has two internal display buffers, allowing two separate values or messages to be viewed. The main display is always enabled and viewable. The secondary display may be enabled or disabled through programming. When enabled, this display is indicated by a "2" on the far right of the display. The main and secondary displays can be toggled either manually or automatically at a user selectable toggle speed. A serial command can also be sent to select which display is shown. Both displays are retained in memory when power is removed from the unit.

The Serial Slave has an internal 64 character buffer for received data. If more than 64 characters are sent, the additional characters are discarded until a string terminator <CR> is received. At that point, the last six characters at the end of the buffer are displayed.

A carriage return <CR> is the only valid string terminator for the Serial Slave. However, if an <\*> or <\$> is received, the slave will empty and reset its internal character buffer without processing the string. These characters are used as valid command terminators for serial commands sent to other Red Lion meters. Since these commands are not applicable to the Serial Slave, the slave discards the command and prepares its character buffer for a new data string.

### Data and Command String Formatting

Data sent to the Serial Slave must be formatted as either main display data, secondary display data or command strings sent to perform specific display functions. The format for sending data is shown below:

N xx I d6 d5 d4 d3 d2 d1 <CR>

**N** - Required to address a specific slave unit in a multiple unit loop.

**xx** - Two-digit meter address. Single digit address requires leading zero.

**I** - Format identifier character (see below). Omit for main display data.

**d6-d1** - The last 6 characters before the <CR> will be shown, if displayable.

**<CR>** - Carriage Return (0DH) used as string terminator character.

The format identifier character <I> dictates how the Serial Slave interprets a data string as follows:

(omit) - No character indicates main display data

# - Indicates secondary display data

@ - Display select command, followed by display identifier character main <1> or secondary <2> (ex: @1<CR> select main display)

% - Display intensity command, followed by intensity level character <1> to <5> (ex: %3<CR> set display intensity level to 3)

### Downloading Data from a G3 to an LDSS

#### Communications:

**Port:** RS232 Comms Raw Serial Port

**Port Driver:** <system> Raw Serial Port

#### Programming:

```
PortPrint(2, "N01" + IntToText(Var1, 10, 6) + "\r");
```

This program is called from the Global On Tick. It sends "N01" (the address of the LDSS), followed by the ASCII equivalent of Var1, then a carriage return.

### Data Receive Delay Timing

Upon receiving a string terminator character <CR>, the Serial Slave requires a delay time to process the received data and prepare for the next string. During this delay, the meter disables serial data reception.

The Data Receive Delay Time is programmable in Module 1, with a minimum delay of 10 mSec. By extending this delay, the Serial Slave can ignore data sent by the host which is not intended for display. This data includes additional characters such as a <LF> or redundant <CR>, which might follow a serial data string. This could also include additional data strings sent as part of a data block, where only the first string is intended for the Serial Slave display. In this case, the delay time should be programmed to exceed the total transmission time for the entire data block. This results in the Serial Slave displaying the first string of the data block and disabling data reception during transmission of the additional strings.

The Receive Delay Time must be set to expire at a point where no data is being sent to the Serial Slave. This prevents the unit from enabling data reception in the middle of a character or data string, which could result in an incorrect display when the string is processed.

### Timing Diagram for Data Reception

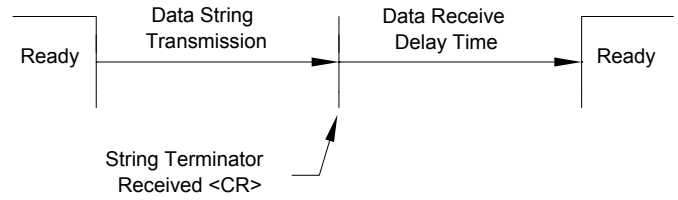

## LD SERIAL SLAVE PROGRAMMING QUICK OVERVIEW

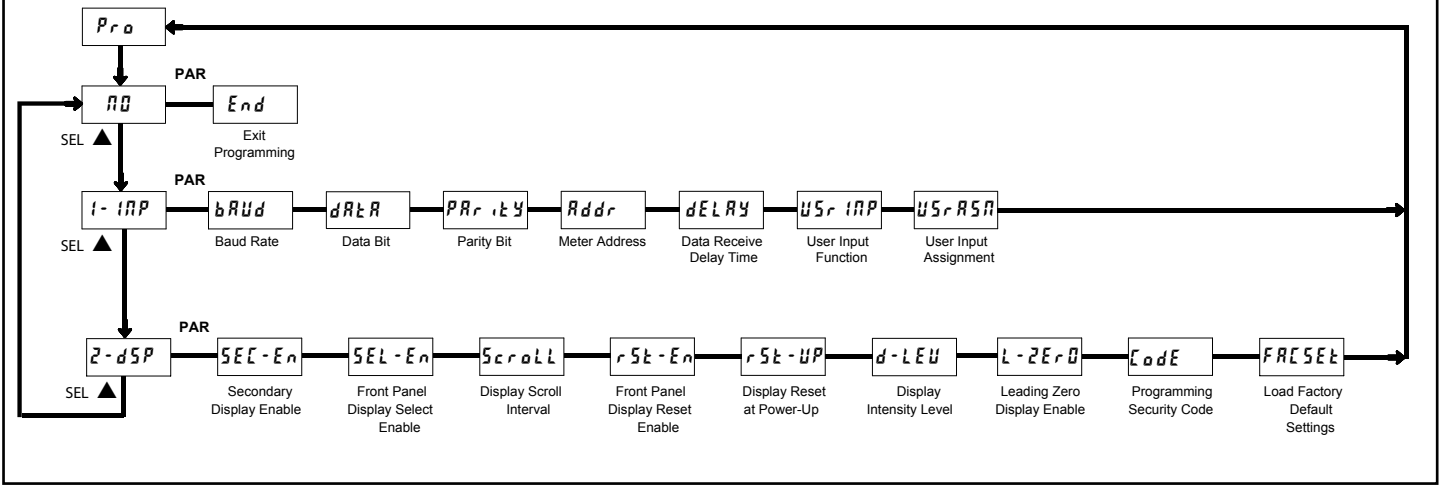

### LIMITED WARRANTY

(a) Red Lion Controls Inc., Sixnet Inc., N-Tron Corporation, or Blue Tree Wireless Data, Inc. (the "Company") warrants that all Products shall be free from defects in material and workmanship under normal use for the period of time provided in "Statement of Warranty Periods" (available at [www.redlion.net](http://www.redlion.net)) current at the time of shipment of the Products (the "Warranty Period"). **EXCEPT FOR THE ABOVE-STATED WARRANTY, COMPANY MAKES NO WARRANTY WHATSOEVER WITH RESPECT TO THE PRODUCTS, INCLUDING ANY (A) WARRANTY OF MERCHANTABILITY; (B) WARRANTY OF FITNESS FOR A PARTICULAR PURPOSE; OR (C) WARRANTY AGAINST INFRINGEMENT OF INTELLECTUAL PROPERTY RIGHTS OF A THIRD PARTY; WHETHER EXPRESS OR IMPLIED BY LAW, COURSE OF DEALING, COURSE OF PERFORMANCE, USAGE OF TRADE OR OTHERWISE.** Customer shall be responsible for determining that a Product is suitable for Customer's use and that such use complies with any applicable local, state or federal law.

(b) The Company shall not be liable for a breach of the warranty set forth in paragraph (a) if (i) the defect is a result of Customer's failure to store, install, commission or maintain the Product according to specifications; (ii) Customer alters or repairs such Product without the prior written consent of Company.

(c) Subject to paragraph (b), with respect to any such Product during the Warranty Period, Company shall, in its sole discretion, either (i) repair or replace the Product; or (ii) credit or refund the price of Product provided that, if Company so requests, Customer shall, at Company's expense, return such Product to Company.

(d) **THE REMEDIES SET FORTH IN PARAGRAPH (c) SHALL BE THE CUSTOMER'S SOLE AND EXCLUSIVE REMEDY AND COMPANY'S ENTIRE LIABILITY FOR ANY BREACH OF THE LIMITED WARRANTY SET FORTH IN PARAGRAPH (a).**